



Design Example Report

Title	<i>3.9W CV/CC Charger using TNY266P with < 100 mW standby</i>
Specification	Input: 85 – 265 VAC Output: 6.5V / 0.6A
Application	Cell Phone Charger
Author	Power Integrations Applications Department
Document Number	DER-33
Date	April 1, 2004
Revision	1.0

Summary and Features

This document is an engineering report describing a 6.5 VDC, 600 mA CV/CC Charger utilizing a TNY266P featuring:

- No load power consumption ~69 mW @ 230V
- Achieves cable-drop compensation with no TL431
- Uses TNY266P
- Low cost , low parts count
- No Y-cap needed to meet CISPR-22 EMI even with artificial hand
- Very low AC leakage current

The products and applications illustrated herein (including circuits external to the products and transformer construction) may be covered by one or more U.S. and foreign patents or potentially by pending U.S. and foreign patent applications assigned to Power Integrations. A complete list of Power Integrations' patents may be found at www.powerint.com.

Table Of Contents

1	Introduction.....	3
2	Photograph.....	3
3	Power Supply Specification.....	4
4	Schematic.....	5
5	Circuit Description.....	6
5.1	Input Rectification, Bulk Capacitance and EMI Filtering.....	6
5.2	Primary DRAIN Voltage Clamp Circuit.....	6
5.3	Auxiliary Bias Supply.....	6
5.4	Output Rectification and Filtering.....	6
5.5	Output Voltage Sensing and Feedback.....	7
6	PCB Layout.....	8
7	Bill Of Materials.....	9
8	Transformer Specification.....	10
8.1	Electrical Diagram.....	10
8.2	Electrical Specifications.....	10
8.3	Materials.....	11
8.4	Transformer Build Diagram.....	11
8.5	Transformer Construction.....	12
9	Transformer Spreadsheets.....	13
10	Performance Data.....	15
10.1	Output Characteristic.....	15
10.2	Efficiency.....	15
10.3	No-load Input Power.....	16
10.4	Load and Line Regulation in CV mode.....	16
11	Thermal Performance.....	17
12	Waveforms.....	18
12.1	Drain Voltage Normal Operation.....	18
12.2	Output Voltage Start-up Profile.....	18
12.3	Drain Voltage Start-up Profile.....	19
12.4	Output Ripple Measurements.....	20
12.4.1	Ripple Measurement Technique.....	20
12.4.2	Measurement Results.....	21
13	Conducted EMI.....	22
14	Revision History.....	23

Important Note:

Although this board is designed to satisfy safety isolation requirements, the engineering prototype has not been agency approved. Therefore, all testing should be performed using an isolation transformer to provide the AC input to the prototype board.

Design Reports contain a power supply design specification, schematic, bill of materials, and transformer documentation. Performance data and typical operation characteristics are included. Typically only a single prototype has been built.



1 Introduction

This document is an engineering report describing a 6.5 VDC, 600 mA CV/CC Charger utilizing a TNY266P.

The TNY266P is implemented as both a switch and controller into a Flyback converter. Cancellation techniques are adopted in the transformer design to make the power supply meet EMI without Y capacitors.

The document contains the power supply specification, schematic, bill of materials, transformer documentation, printed circuit layout, and performance data.

2 Photograph

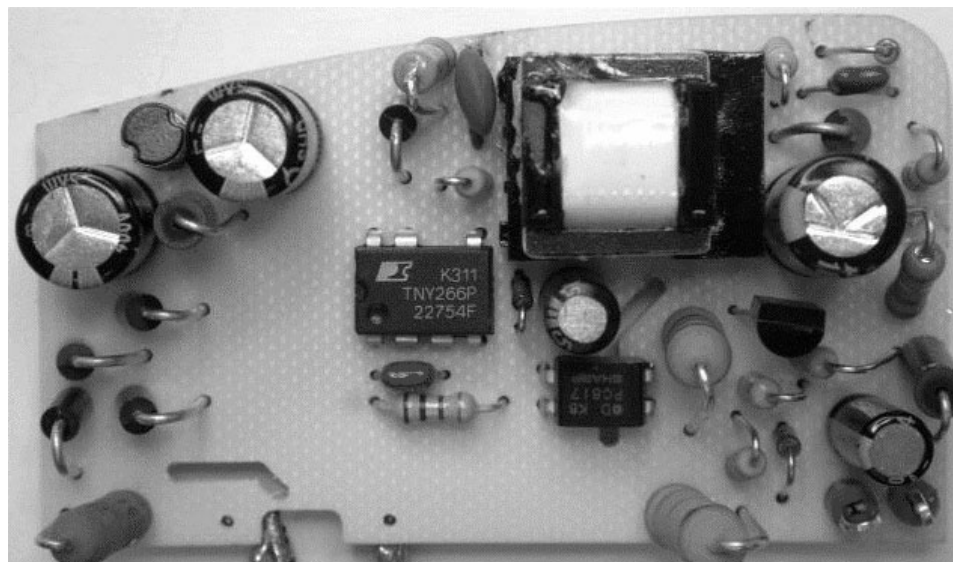

Figure 1 – Populated Circuit Board Photograph.



3 Power Supply Specification

Description	Symbol	Min	Typ	Max	Units	Comment
Input						
Voltage	V_{IN}	85		265	VAC	2 Wire – no P.E.
Frequency	f_{LINE}	47	50/60	64	Hz	
No-load Input Power (230 VAC)				0.1	W	
Output						
Output Voltage 1	V_{OUT1}		6.5		V	±7% 20 MHz Bandwidth
Output Ripple Voltage 1	$V_{RIPPLE1}$			100	mV	
Output Current 1	I_{OUT1}			0.6	A	
Efficiency	η		62		%	Measured at P_{OUT} (3.9 W), 25 °C
Environmental						
Conducted EMI						Meets CISPR22B / EN55022B Designed to meet IEC950, UL1950 Class II
Safety						
Ambient Temperature	T_{AMB}	0		40	°C	Free convection, sea level



4 Schematic

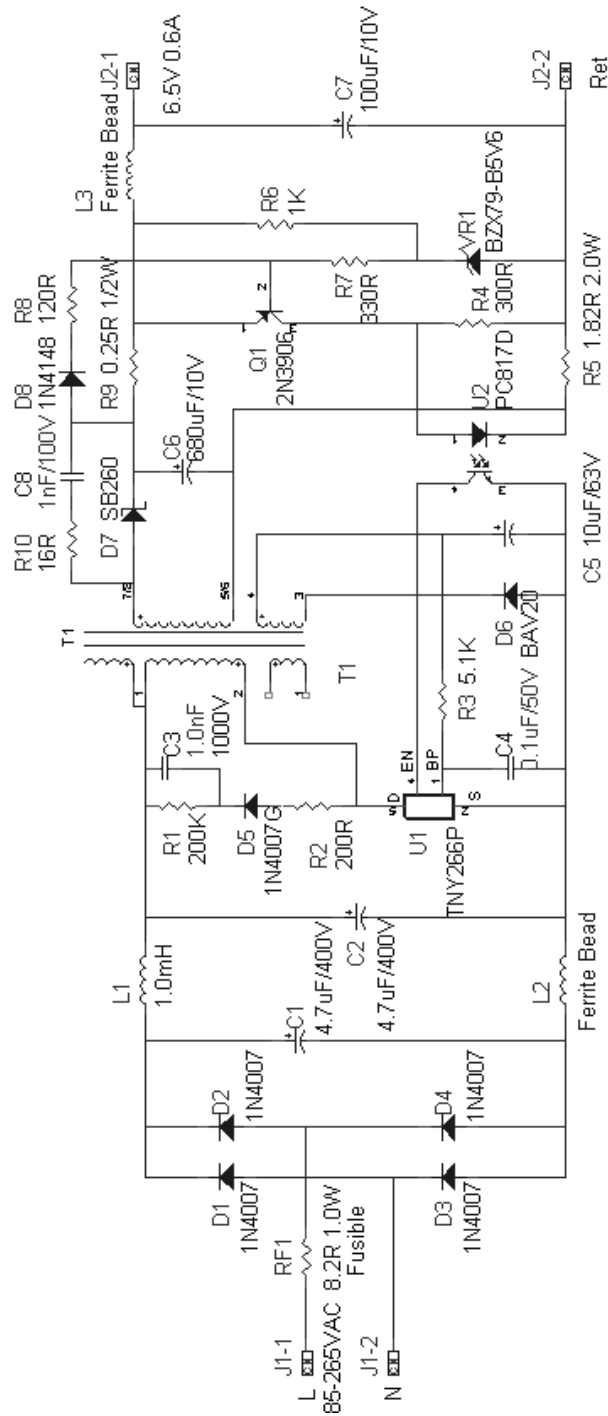

Figure 2 – Schematic.



5 Circuit Description

This circuit is configured as a Flyback operating in both continuous and discontinuous conduction mode. The low standby consumption is achieved by using a high gain opto-coupler, using a bias winding that provides about 10V during no-load, and by designing a low-capacitance transformer.

5.1 Input Rectification, Bulk Capacitance and EMI Filtering

AC input power is rectified by a full bridge, consisting of D1 through D4. The rectified DC is then filtered by the bulk storage capacitors C1 and C2. Inductor L1 and Ferrite bead L2 separate C1 and C2 from each other. L1, C1 and C2 form a pi (π) filter, which attenuates conducted differential-mode EMI noise. Fusible resistor RF1 has multiple functions. It is a fuse, an in-rush current limiting device, a final low pass filter stage (with C1) for conducted EMI attenuation and an initial stage of input surge voltage attenuation.

5.2 Primary DRAIN Voltage Clamp Circuit

The DRAIN voltage clamp circuit is comprised of C3, R1, R2 and diode D5. D5 and C3 clamp the amplitude of the voltage spike that the transformer leakage inductance generates, at switch turn-off, to keep it beneath the device's maximum DRAIN to SOURCE voltage rating (700 V). R2 damps the high frequency ringing caused by leakage inductance, which improves the conducted EMI performance of the circuit.

5.3 Auxiliary Bias Supply

The TinySwitch-II normally does not need a bias supply because it has a high voltage current source to supply the internal chip consumption. If an external current is applied to the BP pin (which is the internal power supply of the chip), it turns off the HV current source and regulates the voltage on the BP pin like a zener. The power dissipated in the HV current source is saved. This power savings is on the order of 50-100 mW. This is needed to achieve a <100mW standby consumption.

The auxiliary bias supply circuit is made up of the primary-side transformer bias winding, diode D6 and capacitor C5. D6 rectifies the output of the winding and C5 filters it. The winding was given just enough turns so that its minimum output voltage stays at 10V at no-load to minimize power consumption. C4 is the standard BP pin decoupling capacitor, which should always be a 50 V 0.1 μ F ceramic capacitor that is located close to the IC. R3 is used to regulate the current into the BP pin.

5.4 Output Rectification and Filtering

Output rectification and filtering are accomplished by Schottky diode D7, capacitors C6 and C7. D7 rectifies the output of the transformer, T1. R10 and C8 dampen out the high frequency interaction between D7, T1 and U1, to reduce conducted EMI noise generation. C6 filters the initial rectified output, while L3 and C7 serve as a secondary low-pass filter stage, which further reduce the output ripple voltage.



5.5 Output Voltage Sensing and Feedback

Transistor Q1, resistors R4, R5, R6, R7, R8, R9, diode D8, Zener diode VR2 and opto-isolator U2 form the CV, CC, and cable drop compensation circuit. Q1, R6, R7, R8, R9, VR2, D8 and U2 comprise the Constant Voltage (CV) mode control loop and cable compensation control loop while R4, R5 and U2 make up the Constant Current (CC) mode control loop.

CC Mode Operation

The CC mode set-point is determined by the voltage drop on the optocoupler LED and the voltage drop on R5. The voltage drop on R4 is quite small and can be ignored. The TinySwitch-II has an EN pin current that is very constant with power delivery, so therefore the current in the optocoupler LED is very constant. For this reason the CC set-point does not change with load voltage.

CV Mode and Cable Drop Compensation Operation

The CV mode set-point is set by the voltage drops on VR1, R7, and the V_{be} of Q1. The voltage on R7 depends on the operation of the cable drop compensation circuit. In order to have a regulated voltage at the end of the cable, the load current produces a voltage drop on R9 which feeds to the Base of Q1, through R8. The net effect is that the voltage set-point increases as the load increases, canceling the voltage drop in the output cable. D6 provides temperature compensation for the temperature coefficient of Q1.



6 PCB Layout

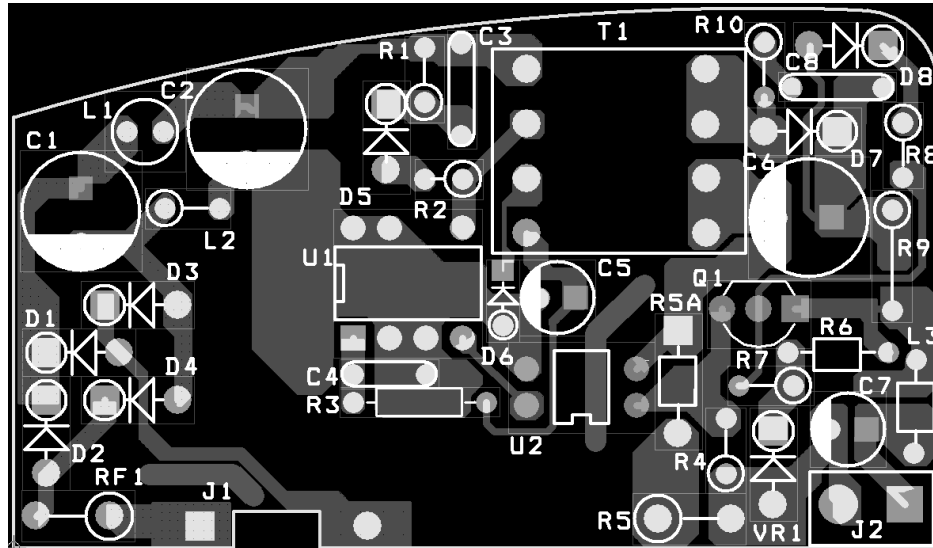

Figure 3 – Printed Circuit Layout.

Note: The total value of R5 and R5A is the value shown in schematic.



7 Bill Of Materials

Item	Qty	Ref	Description	P/N	Mfg
1	2	C1, C2	4.7uF 400V, electrolytic capacitor	KMG400VB4R7M	Nippon Chemi-Con
2	1	C3	1.0nF, 1 kV, ceramic Z5U dielectric		Any
3	1	C4	0.1 μ F, 50 V, ceramic X7R dielectric		Any
4	1	C8	1nF, 100 V, ceramic X7R dielectric		Any
5	1	C5	10 μ F, 63 V	KMG63VB10RM	Nippon Chemi-Con
6	1	C6	680uF, 10V, low esr	KZE10VB681M	Nippon Chemi-Con
7	1	C7	100 μ F, 10 V, low esr	KZE10VB101M	Nippon Chemi-Con
8	4	D1, D2, D3, D4	1 A, 1000 V	1N4007	Any
9	1	D5	1 A, 1000 V, Glass Passivated	1N4007G	Any
10	1	D6	200V, 200mA, Fast	BAV20	Any
11	1	D7	60V, 2A, Schottky	SB260	Any
12	1	D8	75V, 150mA, Fast	1N4148	Any
13	1	J1,	AC Input Connector		Any
14	1	J2	DC output Connector		Any
15	1	L1	1.0mH		Any
16	2	L2, L3	Ferrite Bead		Any
17	1	Q1	40V, 200mA, PNP	2N3906	Any
18	1	RF1	8.2R, 1.0W		Any
19	1	R1	200K, 1/2W		Any
20	1	R2	200R, 1/4W		Any
21	1	R3	5.1K, 1/4W		Any
22	1	R4	300R, 1/4W		Any
23	1	R5	1.82R, 2.0W		Any
24	1	R6	1K, 1/4W		Any
25	1	R7	330R, 1/4W		Any
26	1	R8	120R, 1/4W		Any
27	1	R9	0.25R, 1/2W		Any
28	1	R10	16R, 1/4W		Any
29	1	T1	EE13 Transformer	Custom	Any
30	1	U1	<i>TinySwitch-II</i>	TNY266P	Power Integrations
31	1	U2	Opto-coupler	PC817D	Isocom / Any
32	1	VR1	5.6V, 1/4 W, 2%	BZX79-B5V6	Any



8 Transformer Specification

8.1 Electrical Diagram

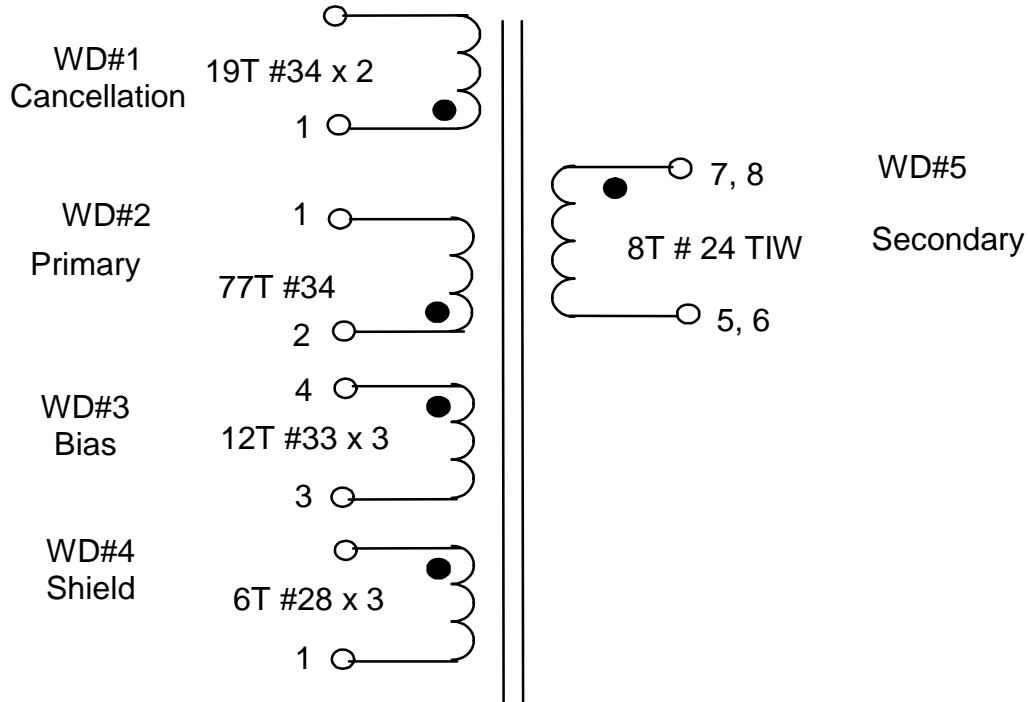

Figure 4 –Transformer Electrical Diagram

8.2 Electrical Specifications

Electrical Strength	1 second, 60 Hz, from Pins 1 - 4 to Pins 5 -8	3000 VAC
Primary Inductance	Pins 1-2, all other windings open, measured at 132 kHz, 0.4 VRMS	1.11 mH, -10/+10%
Resonant Frequency	Pins 1-2, all other windings open	600 kHz (Min.)
Primary Leakage Inductance	Pins 1-2, with Pins 6-7 shorted, measured at 132 kHz, 0.4 VRMS	50 μ H (Max.)

8.3 Materials

Item	Description
[1]	Core: PC40EE13-Z, TDK or equivalent Gapped for AL of 187 nH/T ²
[2]	Bobbin: Horizontal 8 pins
[3]	Magnet Wire: #34 AWG
[4]	Magnet Wire: #33 AWG
[5]	Magnet Wire: #28 AWG
[6]	Triple Insulated Wire: #24 AWG.
[7]	Tape: 3M 1298 Polyester Film, 2.0 mils thick, 7.6 mm wide
[8]	Varnish

8.4 Transformer Build Diagram

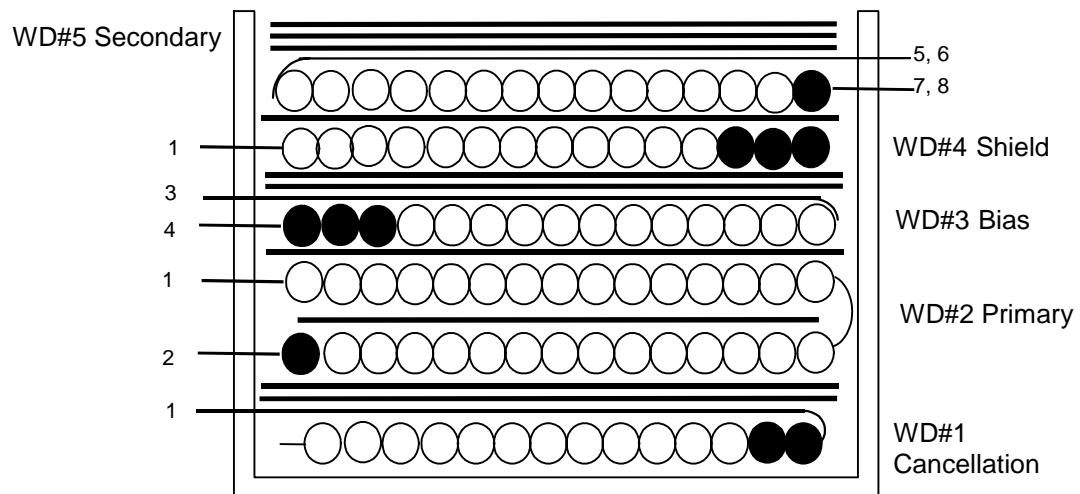

Figure 5 – Transformer Build Diagram.

8.5 Transformer Construction

Bobbin Preparation	Primary pin side of the bobbin orients to the left hand side.
WD#1 Cancellation	Start on Pin 8 temporarily. Wind 19 turns bifilar of item [3] from right to left. Wind with tight tension across entire bobbin evenly. Cut the wire after finishing 19 th turn. Fold the starting lead back and finish it on Pin 1.
Insulation	2 Layers of tape [7] for insulation
WD#2 Primary	Start on pin 2, wind 38 turns of item [3] from left to right. Apply one layer of type [7]. Wind another 39 turns from right to left and finish it on pin 1. Apply one layer of type [7].
Insulation	1 Layers of tape [7] for insulation.
WD#3 Bias	Start on Pin 4, wind 12 trifilar turns of item [4]. Wind from left to right with tight tension. Wind uniformly, in a single layer across entire width of bobbin. Fold back the wire and finish on Pin 3.
Insulation	2 Layers of tape [7] for insulation.
WD #4 Shield	Start at Pin 8 temporarily, wind 6 trifilar turns of item [5]. Wind from right to left with tight tension. Wind uniformly, in a single layer across entire width of bobbin. Finish on Pin 1. Cut the starting lead.
Insulation	1 Layers of tape [7] for insulation.
WD #5	Start at pin 7, wind 8 turns of item [6] from right to left. Wind uniformly, in a single layer across entire bobbin evenly. Bring the wire back and finish on pin 6
Insulation	3 Layers of tape [7] for insulation.
Finish	Grind the core to get 1.11mH. Secure the core with tape. Vanish the transformer



9 Transformer Spreadsheets

ACDC_TNY-II_Rev1_1_032701 Copyright Power Integrations Inc. 2001		INPUT	INFO	OUTPUT	UNIT	ACDC_TNYII_Rev1_1_032701.xls: TinySwitch-II Continuous/Discontinuous Flyback Transformer Design Spreadsheet
ENTER APPLICATION VARIABLES						Customer
VACMIN	85				Volts	Minimum AC Input Voltage
VACMAX	265				Volts	Maximum AC Input Voltage
fL	50				Hertz	AC Mains Frequency
VO	7.8				Volts	Output Voltage
PO	5.26				Watts	Output Power
n	0.7					Efficiency Estimate
Z	0.5					Loss Allocation Factor
tC	3				mSeconds	Bridge Rectifier Conduction Time Estimate
CIN	9.4				uFarads	Input Filter Capacitor
ENTER TinySwitch-II VARIABLES						
TNY-II	TNY266				Universal	115 Doubled/230V
Chosen Device		TNY266	Power Out	9.5W		15W
ILIMITMIN			0.325	Amps		TINYSwitch Minimum Current Limit
ILIMITMAX			0.375	Amps		TINYSwitch Maximum Current Limit
fS			132000	Hertz		TINYSwitch Switching Frequency
fSmin			120000	Hertz		TINYSwitch Minimum Switching Frequency (inc. jitter)
fSmax			144000	Hertz		TINYSwitch Maximum Switching Frequency (inc. jitter)
VOR	80			Volts		Reflected Output Voltage
VDS	7.9			Volts		TINYSwitch on-state Drain to Source Voltage
VD	0.5			Volts		Output Winding Diode Forward Voltage Drop
KP			0.69			Ripple to Peak Current Ratio (0.6<KRP<1.0 : 1.0<KDP<6.0)
ENTER TRANSFORMER CORE/CONSTRUCTION VARIABLES						
Core Type	ee13					
Core		#N/A		P/N:		#N/A
Bobbin		#N/A		P/N:		#N/A
AE		0.171	0.171	cm^2		Core Effective Cross Sectional Area
LE		3.02	3.02	cm		Core Effective Path Length
AL		1130	1130	nH/T^2		Ungapped Core Effective Inductance
BW		7.4	7.4	mm		Bobbin Physical Winding Width
M				mm		Safety Margin Width (Half the Primary to Secondary Creepage Distance)
L	2					Number of Primary Layers
NS	8					Number of Secondary Turns
DC INPUT VOLTAGE PARAMETERS						
VMIN			57	Volts		Minimum DC Input Voltage
VMAX			375	Volts		Maximum DC Input Voltage
CURRENT WAVEFORM SHAPE PARAMETERS						
DMAX			0.62			Maximum Duty Cycle
I AVG			0.13	Amps		Average Primary Current
IP			0.33	Amps		Minimum Peak Primary Current
IR			0.22	Amps		Primary Ripple Current
IRMS			0.17	Amps		Primary RMS Current
TRANSFORMER PRIMARY DESIGN PARAMETERS						
LP			1114	uHenries		Primary Inductance
NP			77			Primary Winding Number of Turns
ALG			187	nH/T^2		Gapped Core Effective Inductance
BM			3167	Gauss		!!!!!!! REDUCE BP<3000 (increase NS,smaller TINYSwitch, larger Core,increase VOR)



BAC			950	Gauss	AC Flux Density for Core Loss Curves (0.5 X Peak to Peak)
ur			1588		Relative Permeability of Ungapped Core
LG		Warning	0.10	mm	!!!!!!! INCREASE GAP>>0.1 (increase NS, decrease VOR,bigger Core
BWE			14.8	mm	Effective Bobbin Width
OD			0.19	mm	Maximum Primary Wire Diameter including insulation
INS			0.04	mm	Estimated Total Insulation Thickness (= 2 * film thickness)
DIA			0.15	mm	Bare conductor diameter
AWG			35	AWG	Primary Wire Gauge (Rounded to next smaller standard AWG value)
CM			32	Cmils	Bare conductor effective area in circular mils
CMA		Warning	183	Cmils/Amp	!!!!!!! INCREASE CMA>200 (increase L(primary layers),decrease NS,larger Core)
TRANSFORMER SECONDARY DESIGN PARAMETERS (SINGLE OUTPUT / SINGLE OUTPUT EQUIVALENT)					
Lumped parameters					
ISP			3.13	Amps	Peak Secondary Current
ISRMS			1.32	Amps	Secondary RMS Current
IO			0.67	Amps	Power Supply Output Current
IRIPPLE			1.14	Amps	Output Capacitor RMS Ripple Current
CMS			264	Cmils	Secondary Bare Conductor minimum circular mils
AWGS			25	AWG	Secondary Wire Gauge (Rounded up to next larger standard AWG value)
DIAS			0.46	mm	Secondary Minimum Bare Conductor Diameter
ODS			0.93	mm	Secondary Maximum Outside Diameter for Triple Insulated Wire
INSS			0.23	mm	Maximum Secondary Insulation Wall Thickness
VOLTAGE STRESS PARAMETERS					
VDRAIN			563	Volts	Maximum Drain Voltage Estimate (Includes Effect of Leakage Inductance)
PIVS			47	Volts	Output Rectifier Maximum Peak Inverse Voltage
TRANSFORMER SECONDARY DESIGN PARAMETERS (MULTIPLE OUTPUTS)					
1st output					
VO1	11.0			Volts	Output Voltage
IO1	0.010			Amps	Output DC Current
PO1			0.11	Watts	Output Power
VD1	0.7			Volts	Output Diode Forward Voltage Drop
NS1			11.28		Output Winding Number of Turns
ISRMS1			0.020	Amps	Output Winding RMS Current
IRIPPLE1			0.02	Amps	Output Capacitor RMS Ripple Current
PIVS1			66	Volts	Output Rectifier Maximum Peak Inverse Voltage



10 Performance Data

All measurements performed at room temperature, 60 Hz input frequency.

10.1 Output Characteristic

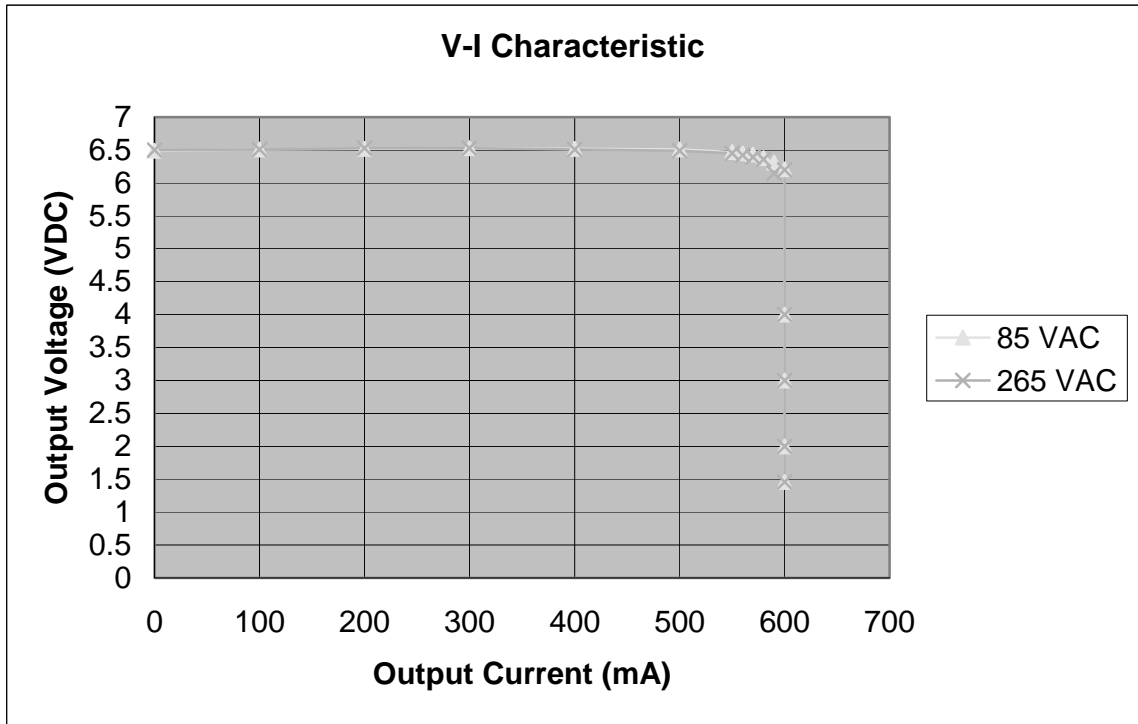

Figure 4 - Typical output characteristic.

10.2 Efficiency

Measured at 0.6A load.

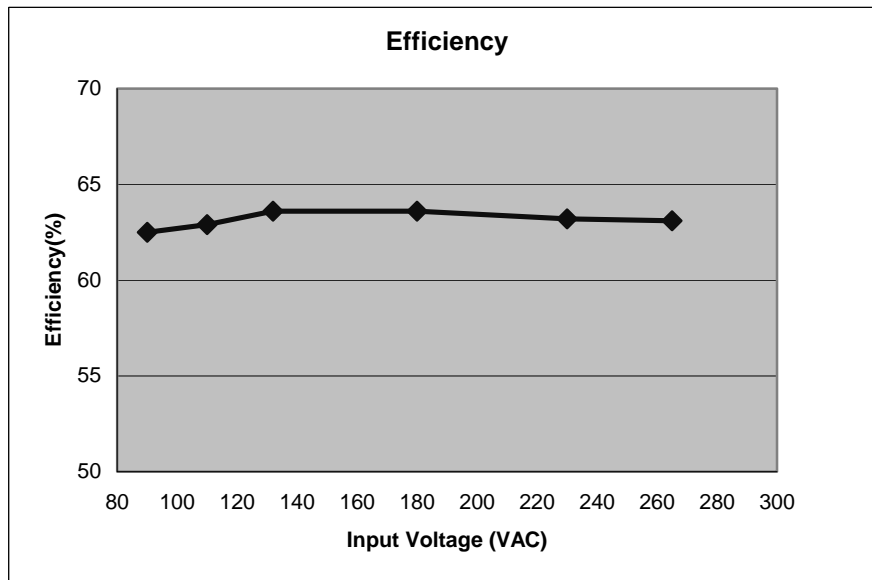

Figure 6- Efficiency vs. Input Voltage at full load, Room Temperature, 60 Hz.



10.3 No-load Input Power

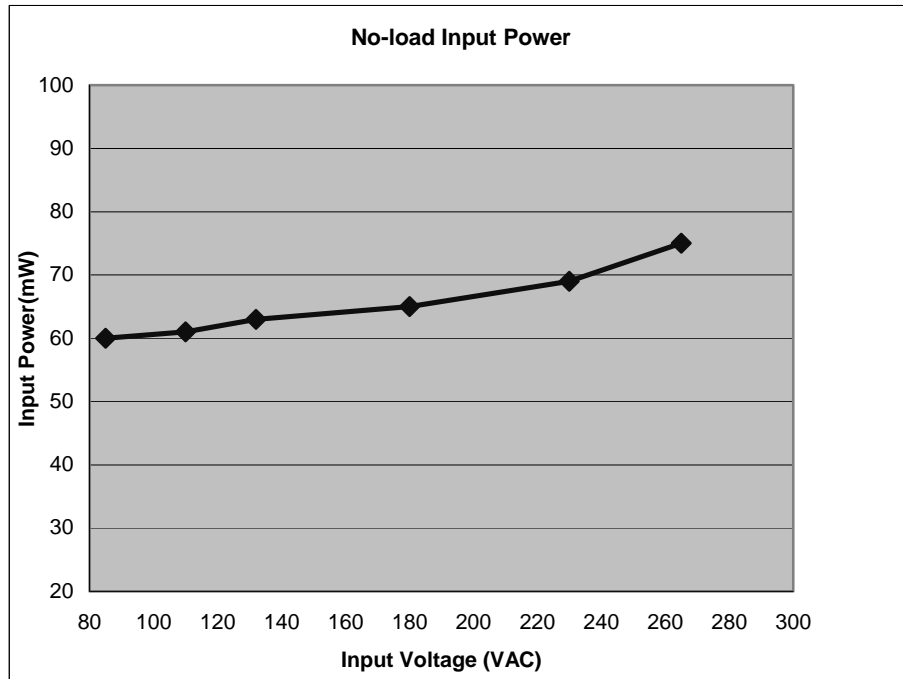

Figure 7- Zero Load Input Power vs. Input Line Voltage, Room Temperature, 60 Hz.

10.4 Load and Line Regulation in CV mode

Measured at the end of a cable with 0.25 Ω resistance. Note the very flat voltage characteristic because of the cable drop compensation.

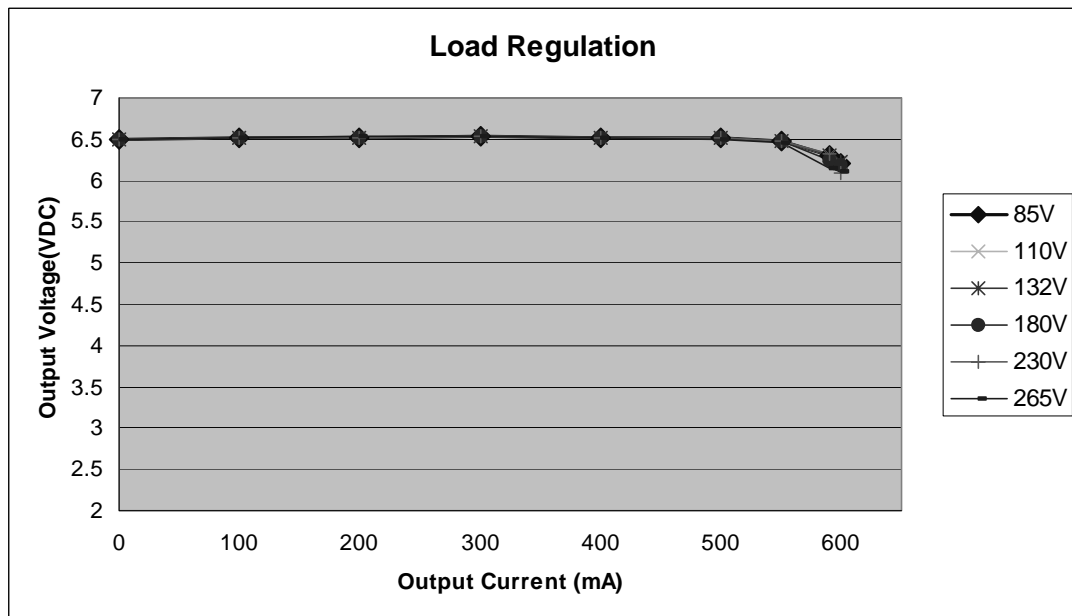

Figure 8 –Load Regulation, Room Temperature.



11 Thermal Performance

Test Condition: Open Air, 0.6A load

Temperature (°C)		
Item	85 VAC	265 VAC
Ambient (Deg.C)	25	25
Transformer (T1)	38	40
<i>TinySwitch-II</i> (U1)	53	53
Rectifier (D7)	56	59



12 Waveforms

12.1 Drain Voltage Normal Operation

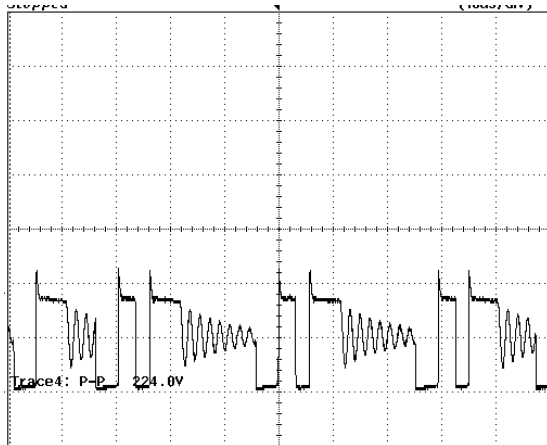

Figure 9 - 85 VAC, Full Load.
Lower: V_{DRAIN} , 100 V, 10 μ s / div

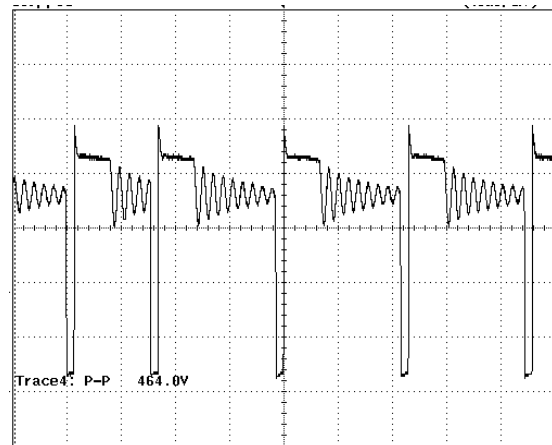

Figure 10 - 265 VAC, Full Load
 V_{DRAIN} , 100 V, 10 μ s / div

12.2 Output Voltage Start-up Profile

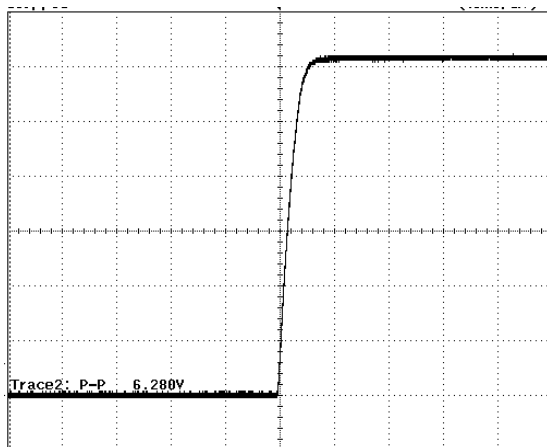

Figure 11 - Start-up Profile, 85VAC
1 V, 10 ms / div.

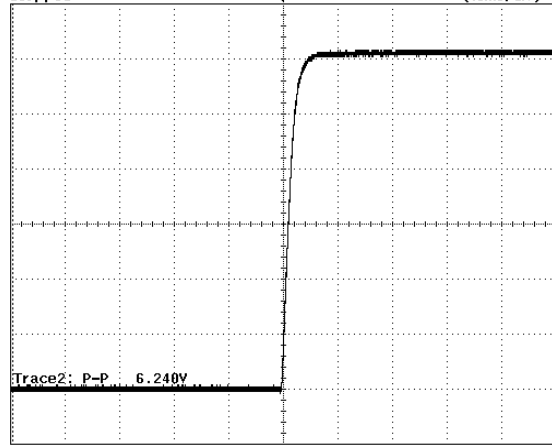

Figure 12 - Start-up Profile, 265 VAC
1 V, 10 ms / div.



12.3 Drain Voltage Start-up Profile

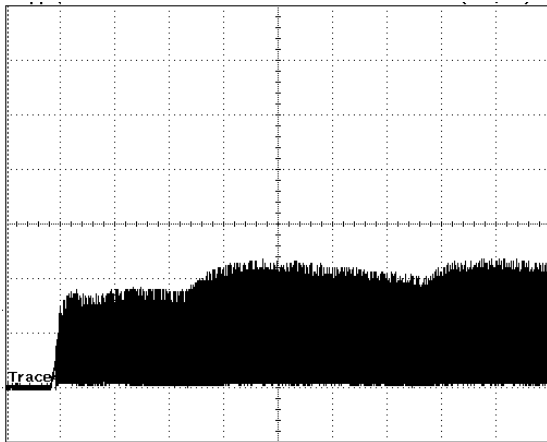

Figure 13 - 85 VAC Input and Maximum Load.
 V_{DRAIN} , 100 V & 2 ms / div.

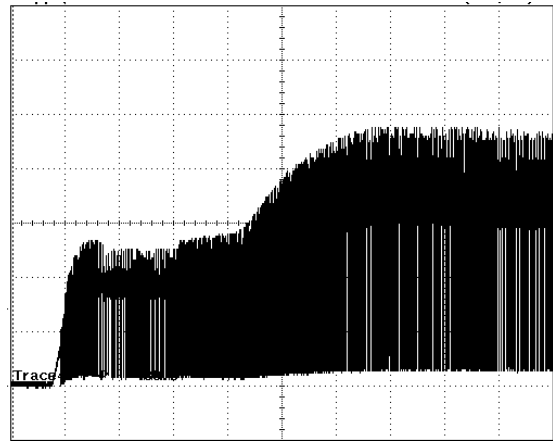

Figure 14 - 265 VAC Input and Maximum Load.
 V_{DRAIN} , 100 V & 1 ms / div.



12.4 Output Ripple Measurements

12.4.1 Ripple Measurement Technique

For DC output ripple measurements, a modified oscilloscope test probe must be utilized in order to reduce spurious signals due to pickup. Details of the probe modification are provided in Figure 19 and Figure 20.

The 5125BA probe adapter is affixed with two capacitors tied in parallel across the probe tip. The capacitors include one (1) 0.1 $\mu\text{F}/50\text{ V}$ ceramic type and one (1) 1.0 $\mu\text{F}/50\text{ V}$ aluminum electrolytic. **The aluminum electrolytic type capacitor is polarized, so proper polarity across DC outputs must be maintained (see below).**

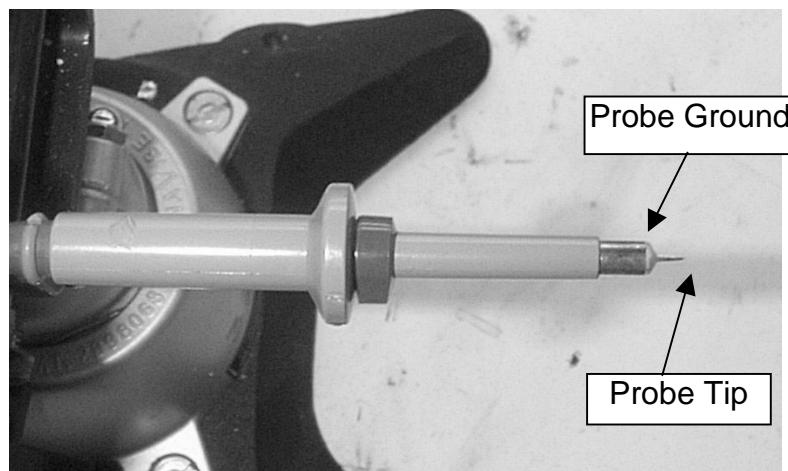

Figure 15 - Oscilloscope Probe Prepared for Ripple Measurement. (End Cap and Ground Lead Removed)

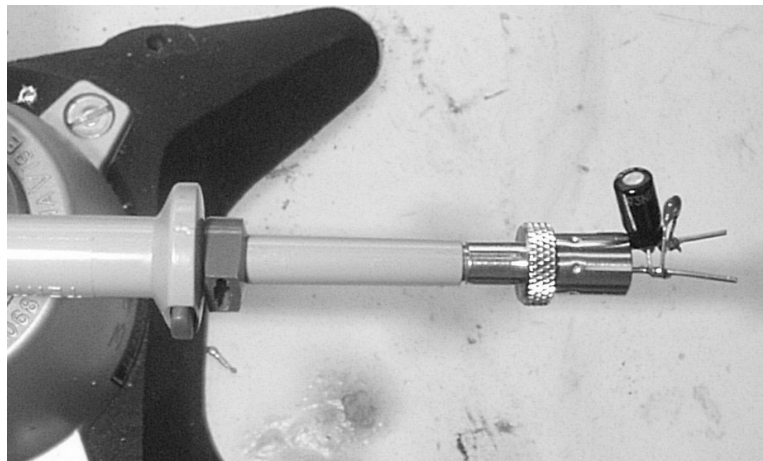

Figure 16 - Oscilloscope Probe with Probe Master 5125BA BNC Adapter. (Modified with wires for probe ground for ripple measurement, and two parallel decoupling capacitors added)

12.4.2 Measurement Results

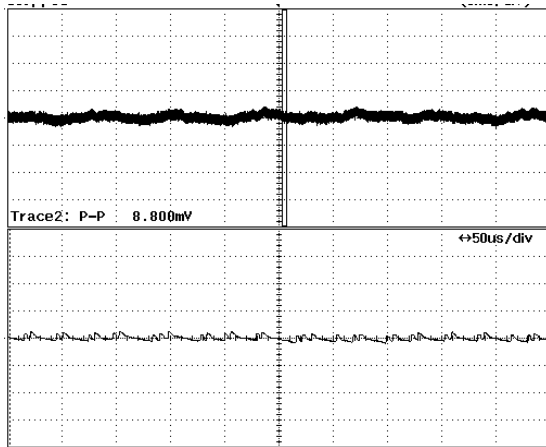

Figure 17 - Ripple, 85 VAC, Full Load.
5 ms, 20 mV / div

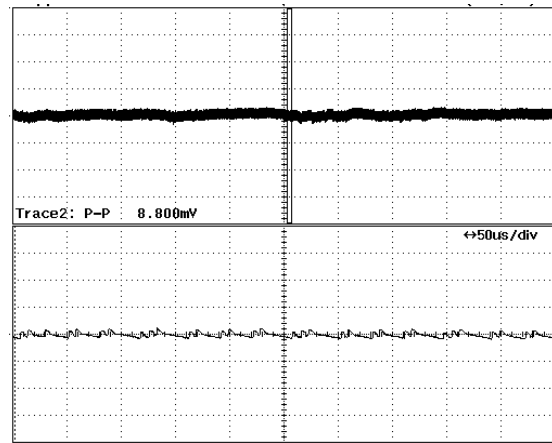

Figure 18 - 5 V Ripple, 110 VAC, Full Load.
5 ms, 20 mV / div

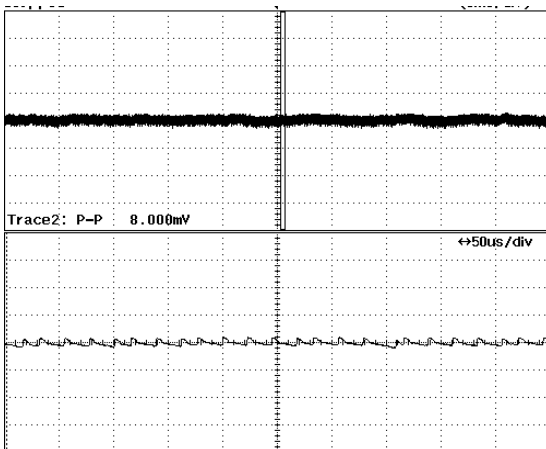
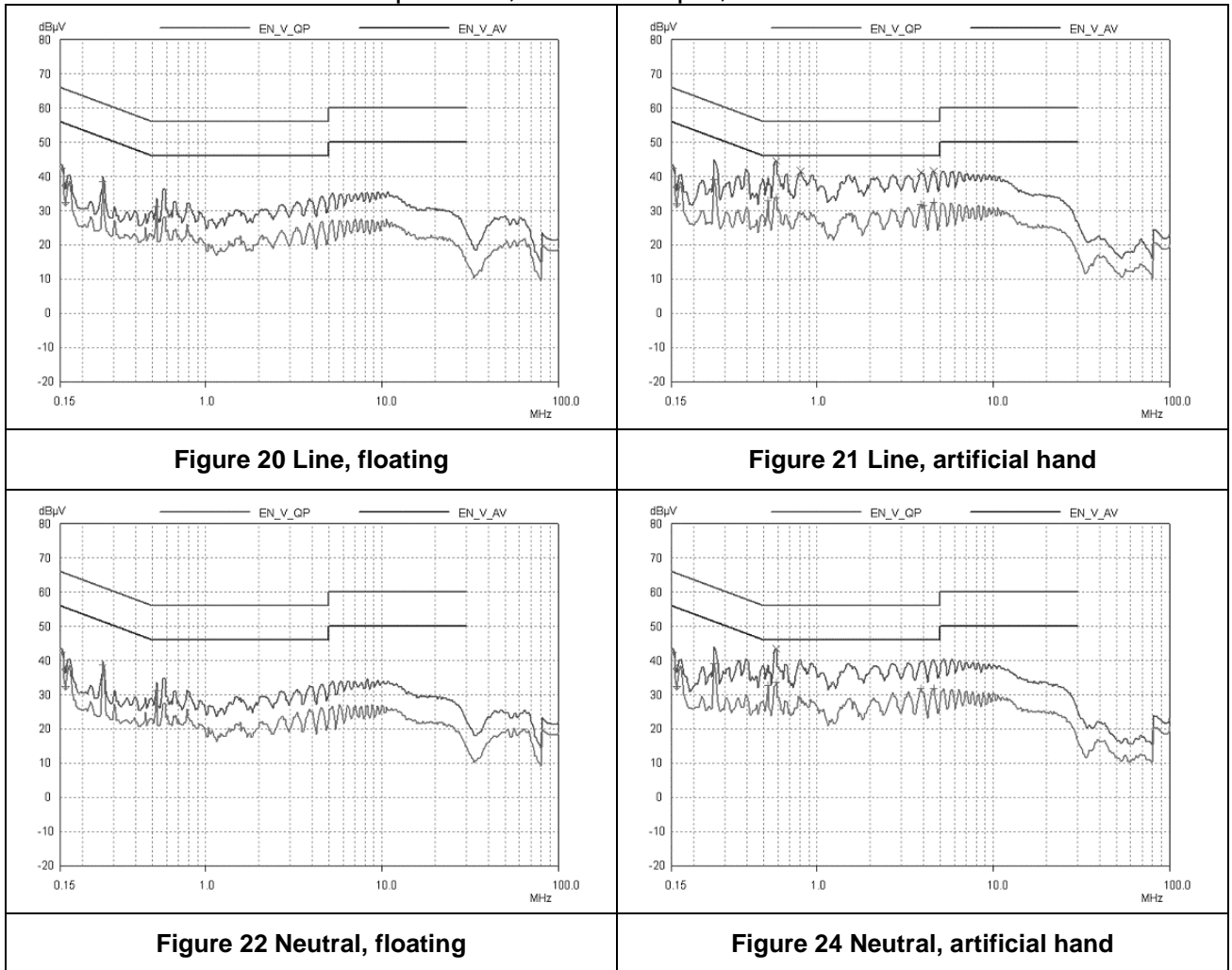

Figure 19 - Ripple, 230 VAC, Full Load.
5 ms, 20 mV / div



13 Conducted EMI

EMI was tested at room temperature, 230 VAC input, full load



14 Revision History

Date	Author	Revision	Description & changes	Reviewed
April 1, 2004	DZ	1.0	First Release	VC /AM



For the latest updates, visit our Web site: www.powerint.com

Power Integrations reserves the right to make changes to its products at any time to improve reliability or manufacturability. Power Integrations does not assume any liability arising from the use of any device or circuit described herein, nor does it convey any license under its patent rights or the rights of others.

The products and applications illustrated herein (including circuits external to the products and transformer construction) may be covered by one or more U.S. and foreign patents or potentially by pending U.S. and foreign patent applications assigned to Power Integrations. A complete list of Power Integrations' patents may be found at www.powerint.com.

The PI Logo, **TOPSwitch**, **TinySwitch**, **LinkSwitch**, and **EcoSmart** are registered trademarks of Power Integrations. **PI Expert** and **DPA-Switch** are trademarks of Power Integrations.

© Copyright 2003, Power Integrations.

WORLD HEADQUARTERS

Power Integrations
5245 Hellyer Avenue,
San Jose, CA 95138, USA
Main: +1-408-414-9200
Customer Service:
Phone: +1-408-414-9665
Fax: +1-408-414-9765
e-mail:
usasales@powerint.com

AMERICAS

Power Integrations, Inc.
4335 South Lee Street,
Suite G,
Buford, GA 30518, USA
Phone: +1-678-714-6033
Fax: +1-678-714-6012
e-mail:
usasales@powerint.com

CHINA (SHANGHAI)

Power Integrations
International Holdings, Inc.
Rm 807, Pacheer,
Commercial Centre,
555 Nanjing West Road,
Shanghai, 200041, China
Phone: +86-21-6215-5548
Fax: +86-21-6215-2468
e-mail:
chinasales@powerint.com

APPLICATIONS HOTLINE

World Wide +1-408-414-9660

CHINA (SHENZHEN)

Power Integrations
International Holdings, Inc.
Rm# 1705, Bao Hua Bldg.
1016 Hua Qiang Bei Lu,
Shenzhen, Guangdong,
518031, China
Phone: +86-755-8367-5143
Fax: +86-755-8377-9610
e-mail: chinasales@powerint.com

GERMANY

Power Integrations, GmbH
Rueckerstrasse 3,
D-80336, Munich, Germany
Phone: +49-895-527-3910
Fax: +49-895-527-3920
e-mail: eurossales@powerint.com

INDIA (TECHNICAL SUPPORT)

Innovatech
#1, (New #42) 8th Main Road,
Vasanthnagar, Bangalore,
India, 560052
Phone: +91-80-226-6023
Fax: +91-80-228-9727
e-mail: indiasales@powerint.com

APPLICATIONS FAX

World Wide +1-408-414-9760

ITALY

Power Integrations s.r.l.
Via Vittorio Veneto 12,
Bresso, Milano,
20091, Italy
Phone: +39-028-928-6001
Fax: +39-028-928-6009
e-mail:
eurossales@powerint.com

JAPAN

Power Integrations, K.K.
Keihin-Tatemono 1st Bldg.
12-20 Shin-Yokohama,
2-Chome,
Kohoku-ku, Yokohama-shi,
Kanagawa 222-0033, Japan
Phone: +81-45-471-1021
Fax: +81-45-471-3717
e-mail:
japansales@powerint.com

KOREA

Power Integrations
International Holdings, Inc.
8th Floor, DongSung Bldg.
17-8 Yoido-dong,
Youngdeungpo-gu,
Seoul, 150-874, Korea
Phone: +82-2-782-2840
Fax: +82-2-782-4427
e-mail:
koreasales@powerint.com

SINGAPORE (ASIA PACIFIC HEADQUARTERS)

Power Integrations, Singapore
51 Newton Road,
#15-08/10 Goldhill Plaza,
Singapore, 308900
Phone: +65-6358-2160
Fax: +65-6358-2015
e-mail:
singaporesales@powerint.com

TAIWAN

Power Integrations
International Holdings, Inc.
17F-3, No. 510,
Chung Hsiao E. Rd., Sec. 5,
Taipei, Taiwan 110, R.O.C.
Phone: +886-2-2727-1221
Fax: +886-2-2727-1223
e-mail:
taiwansales@powerint.com

UK (EUROPE & AFRICA HEADQUARTERS)

Power Integrations (Europe) Ltd.
Centennial Court,
Easthampstead Road,
Bracknell, Berkshire RG12 1YQ,
United Kingdom
Phone: +44-1344-462-300
Fax: +44-1344-311-732
e-mail: eurossales@powerint.com

